

DESIGNER

SERIES

CLASSIC
COLUMN
VERTICAL

CLASSIC COLUMN VERTICAL



50 Δ t

(75/65/20°C)

Height mm	Length mm	Elements	Columns	White UIN		Colour UIN		Watts	Heat output Btu/hr
1800	352	7	2	163054	163054c	868	2962		
	444	9	2	163055	163055c	1116	3809		
2000	352	7	2	163056	163056c	966	3297		
	444	9	2	163057	163057c	1242	4239		
2500	352	7	2	163058	163058c	1197	4085		
	444	9	2	163059	163059c	1539	5253		

Δ t50 is the UK's industry standard for heating outputs, which has an operating temperature of 75/65/20°C. If you have a low temperature heat source you may wish to consider Δ t40 or Δ t30 output (see your installer or system designer or download from www.stelradprofessional.com).

Due to production tolerances, the length of the product and therefore the tap centres could contain a variation of +/- 1.5% of the overall stated length.

For EN442 data, technical and installation information please visit our website: www.stelradprofessional.com and search product downloads.

COLOUR OPTIONS

Comes in White as standard (RAL 9016).

Please note that once a coloured radiator has been ordered, it cannot be cancelled or returned.

Floor mounting brackets are available.

BRACKET INSTALLATION

All dimensions in mm. Inches in brackets.

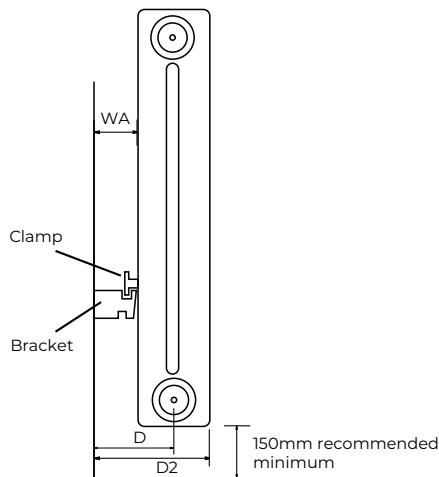

MEASUREMENTS USING 10mm CVD BRACKETS SLOT

Add 5mm if using 15mm slot

	WA	D	D2
2 Col	23	54	85

Number of columns	Wall to centre of connections		Wall to front face of radiator
	Using 10mm bracket slot	Using 15mm bracket slot	
2	54	59	85 or 90

CONNECTIONS

Each radiator comes with ½" inlet connections as standard.



www.stelradprofessional.com

Telephone: 0800 876 6813

EN 442 CERTIFICATION DATA - CETIAT TESTED IN ACCORDANCE WITH BS EN 442

Type	2 Columns		
Height	1800	2000	2500
W/m at 75/65/20	2626	2922	3621
n-coefficients	1.29	1.28	1.28
Heated surface area (m ² /m)	5.93	6.56	8.26
Weight (kg/m) - Elements	50.61	56.11	70.09
Weight (kg/m) - Ends	0.46	0.46	0.46
Water contents (l/m)	31.76	36.00	44.47
Wall to tap centre (mm)	54 / 59	54 / 59	54 / 59

CONNECTIONS

Each radiator comes with ½" inlet connections as standard.

VALVE INSTALLATION

All dimensions in mm. Inches in brackets.

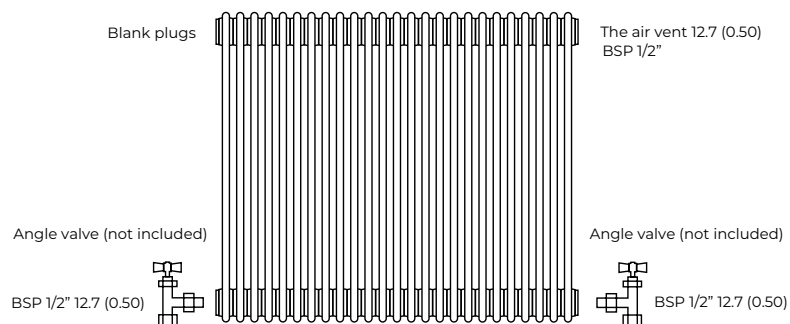

Note: Factory fitted bushes are welded in place and not removable.
If installing TBOE (Top Bottom Opposite End) please note that the radiator MUST be inverted.

55 COLOUR OPTIONS. 14-DAY LEAD TIME.

Stelrad Radiators are available in white (RAL 9016) as standard, however this radiator is **now available in a variety of colours within 14 working days.**

STANDARD COLOUR



RAL 9016
Traffic white

To request up to 5 colour samples, please email sales@stelrad.com or call **0800 876 6813** with your choices and address details.

The colours shown are reproduced as accurately as this printing process will allow.

RAL COLOURS - Satin Finish

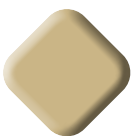

1001
Beige



1013
Oyster white



1015
Light ivory



9001
Cream



9002
Grey white



9003
Signal white



9010
Pure white



9016
Traffic white



9018
Papyrus white



9005
Jet black



9017
Traffic black

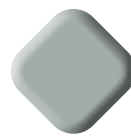

7001
Silver grey

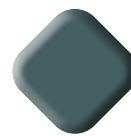

7011
Iron grey

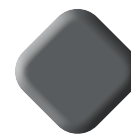

7015
Slate grey

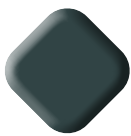

7016
Anthacite grey



7030
Stone grey



7032
Pebble grey



7035
Light grey

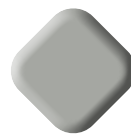

7036
Platinum grey

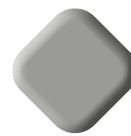

7037
Dusty grey



7038
Agate grey

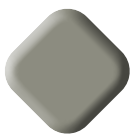

7039
Quartz grey



5002
Ultramarine blue



5010
Gentian blue

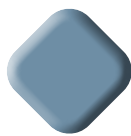

5012
Light blue

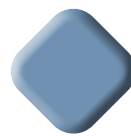

5014
Pigeon blue

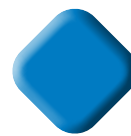

5015
Sky blue

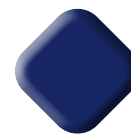

5022
Night blue

Please note: When a coloured radiator or radiators have been ordered they cannot be cancelled or returned.

For further information on RAL colours please visit www.ralcolorchart.com



RAL COLOURS (continued)

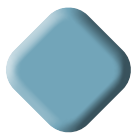

5024
Pastel blue



6005
Light moss green



6018
Yellow green

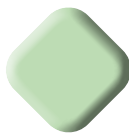

6019
Pastel green

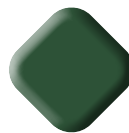

6020
Chrome green

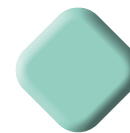

6027
Light green



6033
Mint turquoise

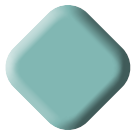

6034
Pastel turquoise



3000
Flame red



3002
Carmine red



3003
Ruby red



3005
Wine red

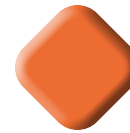

2003
Pastel orange



2008
Bright red orange



1004
Golden yellow



1016
Sulphur yellow



1021
Colza yellow



3015
Light pink

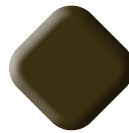

8014
Sepia

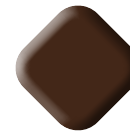

8017
Chocolate brown

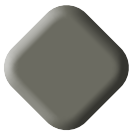

7026
Granite

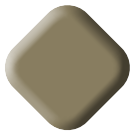

1019
Cappuccino

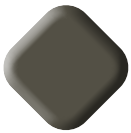

8028
Terra brown

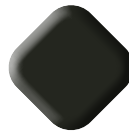

9011
Graphite black

METALLIC

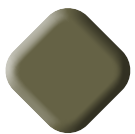

1247M
Bronze metallic



7001M
Silver metallic

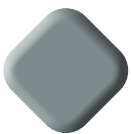

9007M
Grey metallic

Please note: When a coloured radiator or radiators have been ordered they cannot be cancelled or returned.

For further information on RAL colours please visit www.ralcolorchart.com