

DESIGNER

SERIES

CONCORD
LO-LINE

50 Δ t
(75/65/20°C)

DOUBLE

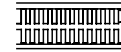

Height mm	Length mm	Elements	White UIN	Colour UIN	Watts	Heat output Btu/hr
148	800	2	148308	148308c	541	1846
	1000	2	148309	148309c	676	2307
	1200	2	148310	148310c	811	2767
	1400	2	148311	148311c	946	3228
	1600	2	148312	148312c	1082	3692
	1800	2	148313	148313c	1217	4153
	2000	2	148314	148314c	1352	4613
	2200*	2	148315	148315c	1487	5074
296	800	4	148316	148316c	894	3050
	1000	4	148317	148317c	1118	3815
	1200	4	148318	148318c	1342	4579
	1400	4	148319	148319c	1565	5340
	1600	4	148320	148320c	1789	6104
	1800	4	148321	148321c	2012	6865
	2000	4	148322	148322c	2236	7630
	2200*	4	148323	148323c	2460	8394

Δ t50 is the UK's industry standard for heating outputs, which has an operating temperature of 75/65/20°C. If you have a low temperature heat source you may wish to consider Δ t40 or Δ t30 output (see your installer or system designer or download from www.stelradprofessional.com).

For EN442 data, technical and installation information please visit our website: www.stelradprofessional.com and search product downloads.

If feet are required, they must be ordered when you purchase your product. The feet are welded on and can not be added to the product once your order has been placed. Optional extra to have no lugs. This needs specifying at the time of ordering. For floorstanding only.

Optional extra to have no lugs. This needs specifying at the time of ordering. For floorstanding only.

FLOOR MOUNTING BRACKET INFORMATION

500 - 1400mm	2 feet
1600 - 3000mm	3 feet

COLOUR OPTIONS

Comes in White as standard (RAL 9016).

Colour radiators have a lead time of up to 8 weeks for configurable options, and a 14-day lead time for nonconfigurable products (from order to delivery). Please note that once a coloured radiator has been ordered, it cannot be cancelled or returned.

* For coloured options over 2200mm in length, please contact Customer Services to discuss the lead time



WALL MOUNTING INFORMATION

All dimensions in mm.

Type	From back of radiator to wall		From wall to centre of connections		From front of radiator to wall	
	mm	inch	mm	inch	mm	inch
Lo-line	25	0.98	97	3.81	125	4.92

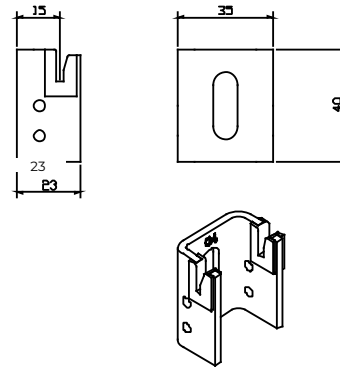

FLOOR MOUNTING POSITIONS

All dimensions in mm. Must be specified at time of ordering as they are securely welded during manufacture.

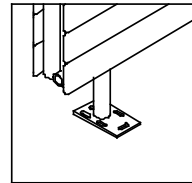
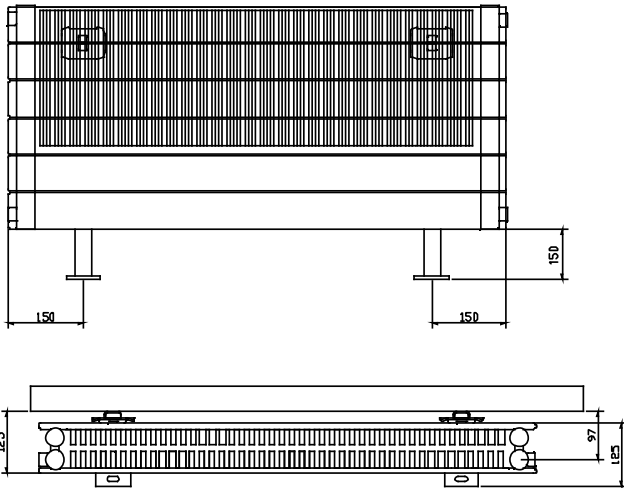

LO-LINE FIXING POSITIONS

All dimensions in mm.

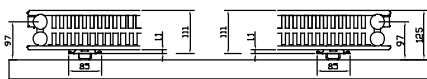

3 brackets 800 to 1400

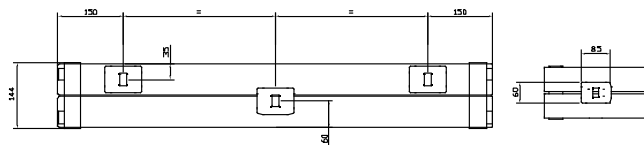

4 brackets 800 to 1400

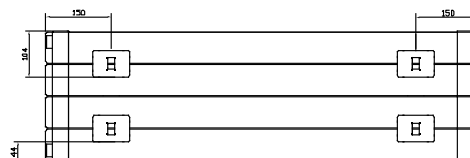

6 brackets 1600 to 2200

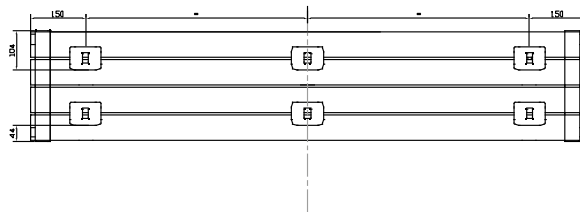

CONNECTIONS

Each radiator comes with ½" inlet connections as standard.

PIPING INSTRUCTIONS

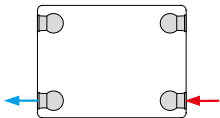
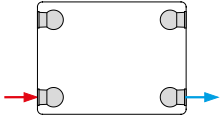

EN 442 CERTIFICATION DATA - CETIAT TESTED IN ACCORDANCE WITH BS EN 442

Type	Lo-Line	
Height	148	296
W/m at 75/65/20	676	1118
n-coefficients	1.25	1.25
Heated surface area (m ² /m)	1.05	1.95
Weight (kg/m)	11.74	22.06
Water contents (l/m)	2.44	4.89
Wall to tap centre (mm)	97	97

55 COLOUR OPTIONS. 14-DAY LEAD TIME.

Stelrad Radiators are available in white (RAL 9016) as standard, however this radiator is **now available in a variety of colours within 14 working days.**

STANDARD COLOUR



RAL 9016
Traffic white

To request up to 5 colour samples, please email sales@stelrad.com or call **0800 876 6813** with your choices and address details.

The colours shown are reproduced as accurately as this printing process will allow.

RAL COLOURS - Satin Finish



1001
Beige



1013
Oyster white



1015
Light ivory



9001
Cream



9002
Grey white



9003
Signal white



9010
Pure white



9016
Traffic white



9018
Papyrus white



9005
Jet black



9017
Traffic black

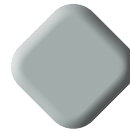

7001
Silver grey

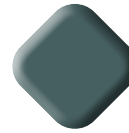

7011
Iron grey

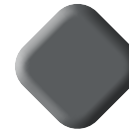

7015
Slate grey

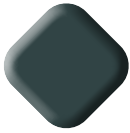

7016
Anthracite grey



7030
Stone grey



7032
Pebble grey



7035
Light grey

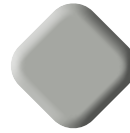

7036
Platinum grey

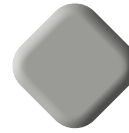

7037
Dusty grey



7038
Agate grey



7039
Quartz grey



5002
Ultramarine blue

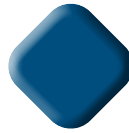

5010
Gentian blue

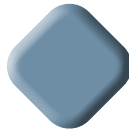

5012
Light blue

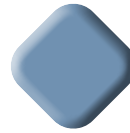

5014
Pigeon blue



5015
Sky blue

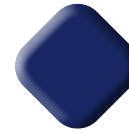

5022
Night blue

Please note: When a coloured radiator or radiators have been ordered they cannot be cancelled or returned.

For further information on RAL colours please visit www.ralcolorchart.com



RAL COLOURS (continued)

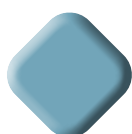

5024
Pastel blue



6005
Light moss green



6018
Yellow green

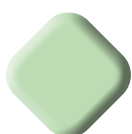

6019
Pastel green

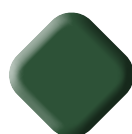

6020
Chrome green



6027
Light green

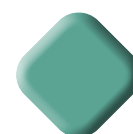

6033
Mint turquoise

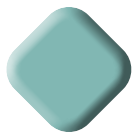

6034
Pastel turquoise



3000
Flame red



3002
Carmine red



3003
Ruby red



3005
Wine red

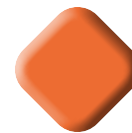

2003
Pastel orange



2008
Bright red orange



1004
Golden yellow



1016
Sulphur yellow



1021
Colza yellow



3015
Light pink

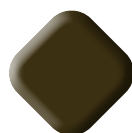

8014
Sepia



8017
Chocolate brown

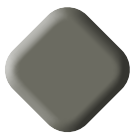

7026
Granite

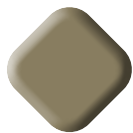

1019
Cappuccino

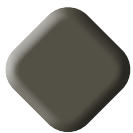

8028
Terra brown



9011
Graphite black

METALLIC

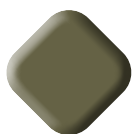

1247M
Bronze metallic



7001M
Silver metallic

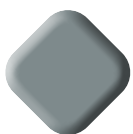

9007M
Grey metallic

Please note: When a coloured radiator or radiators have been ordered they cannot be cancelled or returned.

For further information on RAL colours please visit
www.ralcolorchart.com