

SOFTLINE

SERIES



**COLUMN
HORIZONTAL**

50 Δ t

(75/65/20°C)

2 COLUMN

Height mm	Length mm	White UIN	Colour UIN	Watts	Heat output Btu/h
500	628	563012	563012c	499	1703
	858	563013	563013c	691	2358
	1042	563014	563014c	845	2884
	1272	563015	563015c	1037	3539
600	628	563028	563028c	589	2010
	858	563029	563029c	815	2782
	1042	563030	563030c	997	3403
	1272	563031	563031c	1223	4174

3 COLUMN

4 COLUMN

Height mm	Length mm	White UIN	Colour UIN	Heat output		Length mm	White UIN	Colour UIN	Heat output	
				Watts	Btu/hr				Watts	Btu/hr
300	444	563000	563000c	288	983	444	563007	563007c	377	1287
	628	563001	563001c	416	1420	628	563008	563008c	545	1860
	858	563002	563002c	576	1966	858	563009	563009c	754	2573
	1042	563003	563003c	704	2403	1042	563010	563010c	922	3147
	1272	563004	563004c	864	2949	1272	563011	563011c	1131	3860
	1456	563005	563005c	992	3386	-	-	-	-	-
	1870	563006	563006c	1280	4369	-	-	-	-	-
500	444	563016	563016c	464	1584	444	563023	563023c	608	2075
	628	563017	563017c	671	2290	628	563024	563024c	879	3000
	858	563018	563018c	929	3171	858	563025	563025c	1217	4154
	1042	563019	563019c	1135	3874	1042	563026	563026c	1487	5075
	1272	563020	563020c	1393	4754	1272	563027	563027c	1825	6229
	1456	563021	563021c	1600	5461	-	-	-	-	-
	1870	563022	563022c	2064	7044	-	-	-	-	-
600	444	563032	563032c	548	1870	444	563039	563039c	718	2451
	628	563033	563033c	792	2703	628	563040	563040c	1037	3539
	858	563034	563034c	1096	3741	858	563041	563041c	1436	4901
	1042	563035	563035c	1340	4573	1042	563042	563042c	1756	5993
	1272	563036	563036c	1644	5611	1272	563043	563043c	2155	7355
	1456	563037	563037c	1888	6444	-	-	-	-	-
	1870	563038	563038c	2436	8314	-	-	-	-	-
750	444	-	-	-	-	444	563049	563049c	877	2993
	628	-	-	-	-	628	563050	563050c	1266	4321
	858	563044	563044c	1337	4563	858	563051	563051c	1753	5983
	1042	563045	563045c	1635	5580	1042	563052	563052c	2143	7314
	1272	563046	563046c	2006	6846	1272	563053	563053c	2630	8976
	1456	563047	563047c	2303	7860	-	-	-	-	-
	1870	563048	563048c	2972	10143	-	-	-	-	-

Δ t50 is the UK's industry standard for heating outputs, which has an operating temperature of 75/65/20°C. If you have a low temperature heat source you may wish to consider Δ t40 or Δ t30 output (see your installer or system designer or download from www.stelradprofessional.com).

Due to production tolerances, the length of the product and therefore the tap centres could contain a variation of +/- 1.5% of the overall stated length.

For EN442 data, technical and installation information please visit our website: www.stelradprofessional.com and search product downloads.

COLOUR OPTIONS

Comes in White as standard (RAL 9016).

Please note that once a coloured radiator has been ordered, it cannot be cancelled or returned.

Floor mounting brackets are available.



COLUMN HORIZONTAL



CLASSIC COLUMN HORIZONTAL FLOOR MOUNTING BRACKETS



UIN 148137 White
(sold in pairs)

OPTIONAL FLOOR MOUNTING BRACKETS

All dimensions in mm. Inches in brackets.

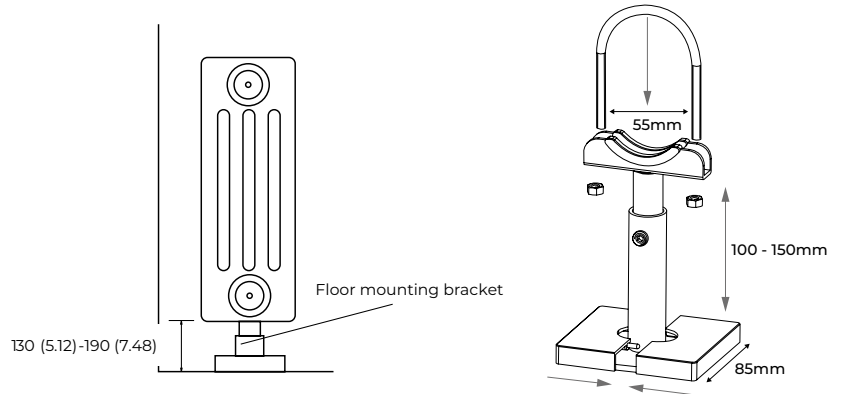

BRACKET INSTALLATION

All dimensions in mm. Inches in brackets.

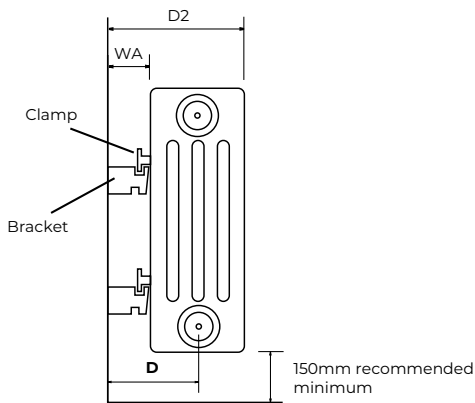

MEASUREMENTS USING 10mm CVD BRACKETS SLOT

Add 5mm if using 15mm slot

	WA	D	D2
2 Col	23	54	85
3 Col	23	73	123
4 Col	23	91	159

BRACKETS AND CLAMPS REQUIRED

	No of Sections
4	0 - 23
6	24 - 41

Number of columns	Wall to centre of connections		Wall to front face of radiator
	Using 10mm bracket slot	Using 15mm bracket slot	
2	54	59	85 or 90
3	73	78	123 or 128
4	91	96	159 or 164

All sizes (approximate) in mm

CONNECTIONS

Each radiator comes with 1/2" inlet connections as standard.

VALVE INSTALLATION

All dimensions in mm. Inches in brackets.

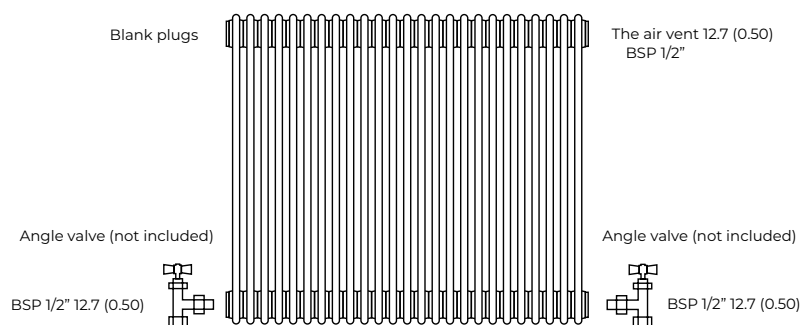

Note: Factory fitted bushes are welded in place and not removable.
If installing TBOE (Top Bottom Opposite End) please note that the radiator **MUST** be inverted.

EN 442 CERTIFICATION DATA - CETIAT TESTED IN ACCORDANCE WITH BS EN 442

Type	2 Columns		3 Columns				4 Columns			
	500	600	300	500	600	750	300	500	600	750
Height	500	600	300	500	600	750	300	500	600	750
W/m at 75/65/20	813	959	678	1093	1289	1573	887	1431	1690	2062
n-coefficients	1.25	1.25	1.28	1.27	1.27	1.26	1.28	1.27	1.27	1.26
Heated surface area (m ² /m)	1.48	1.91	1.48	2.33	2.96	3.60	1.91	3.18	4.02	4.87
Weight (kg/m) - Elements	14.61	17.36	13.34	21.81	26.04	32.18	18.63	30.07	35.36	43.62
Weight (kg/m) - Ends	0.46	0.46	0.56	0.56	0.56	0.56	0.56	0.56	0.56	0.56
Water contents (l/m)	10.59	12.70	12.70	16.94	19.06	23.29	14.82	21.17	25.41	29.64
Wall to tap centre (mm)	54 / 59	54 / 59	73 / 78	73 / 78	73 / 78	73 / 78	91 / 96	91 / 96	91 / 96	91 / 96

55 COLOUR OPTIONS. 14-DAY LEAD TIME.

Stelrad Radiators are available in white (RAL 9016) as standard, however this radiator is **now available in a variety of colours within 14 working days.**

STANDARD COLOUR



RAL 9016
Traffic white

To request up to 5 colour samples, please email sales@stelrad.com or call **0800 876 6813** with your choices and address details.

The colours shown are reproduced as accurately as this printing process will allow.

RAL COLOURS - Satin Finish

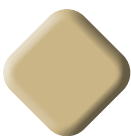

1001
Beige



1013
Oyster white



1015
Light ivory



9001
Cream



9002
Grey white



9003
Signal white



9010
Pure white



9016
Traffic white



9018
Papyrus white



9005
Jet black



9017
Traffic black

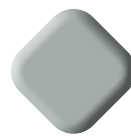

7001
Silver grey

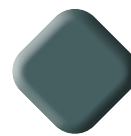

7011
Iron grey

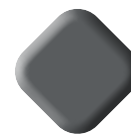

7015
Slate grey

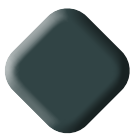

7016
Anthracite grey

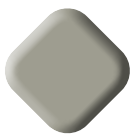

7030
Stone grey



7032
Pebble grey



7035
Light grey

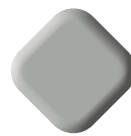

7036
Platinum grey

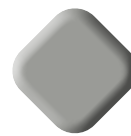

7037
Dusty grey



7038
Agate grey

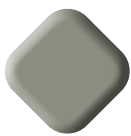

7039
Quartz grey



5002
Ultramarine blue



5010
Gentian blue

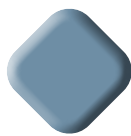

5012
Light blue

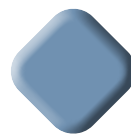

5014
Pigeon blue

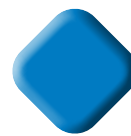

5015
Sky blue

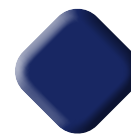

5022
Night blue

Please note: When a coloured radiator or radiators have been ordered they cannot be cancelled or returned.

For further information on RAL colours please visit www.ralcolorchart.com



RAL COLOURS (continued)

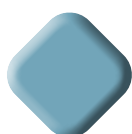

5024
Pastel blue



6005
Light moss green



6018
Yellow green

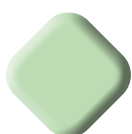

6019
Pastel green

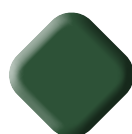

6020
Chrome green



6027
Light green

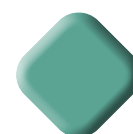

6033
Mint turquoise

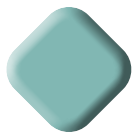

6034
Pastel turquoise



3000
Flame red



3002
Carmine red



3003
Ruby red



3005
Wine red

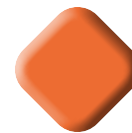

2003
Pastel orange



2008
Bright red orange



1004
Golden yellow



1016
Sulphur yellow



1021
Colza yellow



3015
Light pink

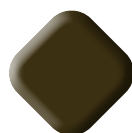

8014
Sepia



8017
Chocolate brown

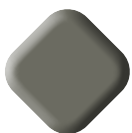

7026
Granite

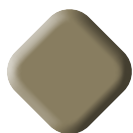

1019
Cappuccino

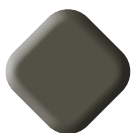

8028
Terra brown

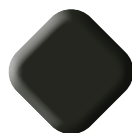

9011
Graphite black

METALLIC

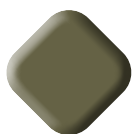

1247M
Bronze metallic



7001M
Silver metallic

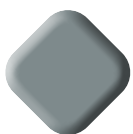

9007M
Grey metallic

Please note: When a coloured radiator or radiators have been ordered they cannot be cancelled or returned.

For further information on RAL colours please visit
www.ralcolorchart.com