

VITA

SERIES



COLUMN
HORIZONTAL

50 Δ t

(75/65/20°C)

2 COLUMN

Height mm	Length mm	White UIN	Colour UIN	Heat output Watts	Heat output Btu/h
500	628	463012	463012c	499	1703
	858	463013	463013c	691	2358
	1042	463014	463014c	845	2884
	1272	463015	463015c	1037	3539
600	628	463028	463028c	589	2010
	858	463029	463029c	815	2782
	1042	463030	463030c	997	3403
	1272	463031	463031c	1223	4174

3 COLUMN

4 COLUMN

Height mm	Length mm	White UIN	Colour UIN	Heat output		Length mm	White UIN	Colour UIN	Heat output	
				Watts	Btu/hr				Watts	Btu/hr
300	444	463000	463000c	288	983	444	463007	463007c	377	1287
	628	463001	463001c	416	1420	628	463008	463008c	545	1860
	858	463002	463002c	576	1966	858	463009	463009c	754	2573
	1042	463003	463003c	704	2403	1042	463010	463010c	922	3147
	1272	463004	463004c	864	2949	1272	463011	463011c	1131	3860
	1456	463005	463005c	992	3386	-	-	-	-	-
500	1870	463006	463006c	1280	4369	-	-	-	-	-
	444	463016	463016c	464	1584	444	463023	463023c	608	2075
	628	463017	463017c	671	2290	628	463024	463024c	879	3000
	858	463018	463018c	929	3171	858	463025	463025c	1217	4154
	1042	463019	463019c	1135	3874	1042	463026	463026c	1487	5075
	1272	463020	463020c	1393	4754	1272	463027	463027c	1825	6229
600	1456	463021	463021c	1600	5461	-	-	-	-	-
	1870	463022	463022c	2064	7044	-	-	-	-	-
	444	463032	463032c	548	1870	444	463039	463039c	718	2451
	628	463033	463033c	792	2703	628	463040	463040c	1037	3539
	858	463034	463034c	1096	3741	858	463041	463041c	1436	4901
	1042	463035	463035c	1340	4573	1042	463042	463042c	1756	5993
750	1272	463036	463036c	1644	5611	1272	463043	463043c	2155	7355
	1456	463037	463037c	1888	6444	-	-	-	-	-
	1870	463038	463038c	2436	8314	-	-	-	-	-
	444	-	-	-	-	444	463049	463049c	877	2993
	628	-	-	-	-	628	463050	463050c	1266	4321
	858	463044	463044c	1337	4563	858	463051	463051c	1753	5983
750	1042	463045	463045c	1635	5580	1042	463052	463052c	2143	7314
	1272	463046	463046c	2006	6846	1272	463053	463053c	2630	8976
	1456	463047	463047c	2303	7860	1456	-	-	-	-
	1870	463048	463048c	2972	10143	1870	-	-	-	-

Δ t50 is the UK's industry standard for heating outputs, which has an operating temperature of 75/65/20°C. If you have a low temperature heat source you may wish to consider Δ t40 or Δ t30 output (see your installer or system designer or download from www.stelradprofessional.com).

Due to production tolerances, the length of the product and therefore the tap centres could contain a variation of +/- 1.5% of the overall stated length.

For EN442 data, technical and installation information please visit our website: www.stelradprofessional.com and search product downloads.

COLOUR OPTIONS

Comes in White as standard (RAL 9016).

Please note that once a coloured radiator has been ordered, it cannot be cancelled or returned.

Floor mounting brackets are available.



CLASSIC COLUMN HORIZONTAL



CLASSIC COLUMN HORIZONTAL FLOOR MOUNTING BRACKETS



UIN 148137 White
(sold in pairs)

OPTIONAL FLOOR MOUNTING BRACKETS

All dimensions in mm. Inches in brackets.

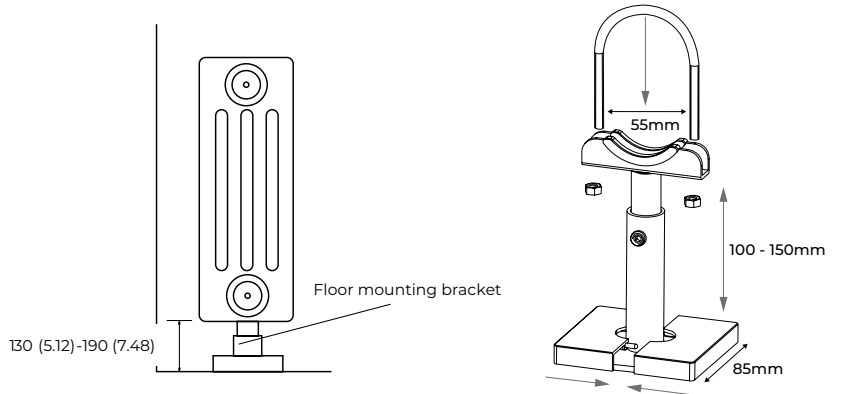

BRACKET INSTALLATION

All dimensions in mm. Inches in brackets.

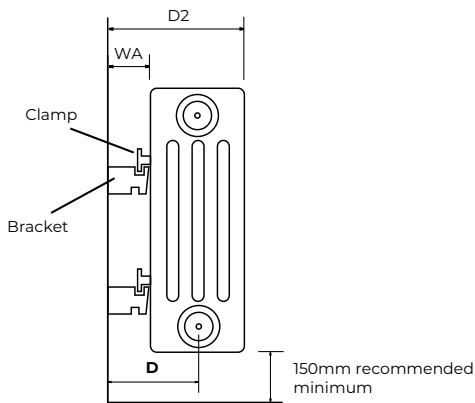

MEASUREMENTS USING 10mm CVD BRACKETS SLOT

Add 5mm if using 15mm slot

	WA	D	D2
2 Col	23	54	85
3 Col	23	73	123
4 Col	23	91	159

BRACKETS AND CLAMPS REQUIRED

	No of Sections
4	0 - 23
6	24 - 41

Number of columns	Wall to centre of connections		Wall to front face of radiator
	Using 10mm bracket slot	Using 15mm bracket slot	
2	54	59	85 or 90
3	73	78	123 or 128
4	91	96	159 or 164

All sizes (approximate) in mm

CONNECTIONS

Each radiator comes with 1/2" inlet connections as standard.

VALVE INSTALLATION

All dimensions in mm. Inches in brackets.

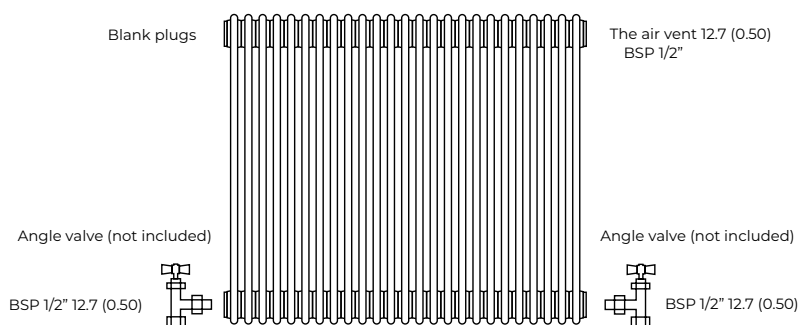

Note: Factory fitted bushes are welded in place and not removable.
If installing TBOE (Top Bottom Opposite End) please note that the radiator MUST be inverted.

EN 442 CERTIFICATION DATA - CETIAT TESTED IN ACCORDANCE WITH BS EN 442

Type	2 Columns		3 Columns				4 Columns			
	500	600	300	500	600	750	300	500	600	750
Height	500	600	300	500	600	750	300	500	600	750
W/m at 75/65/20	813	959	678	1093	1289	1573	887	1431	1690	2062
n-coefficients	1.25	1.25	1.28	1.27	1.27	1.26	1.28	1.27	1.27	1.26
Heated surface area (m ² /m)	1.48	1.91	1.48	2.33	2.96	3.60	1.91	3.18	4.02	4.87
Weight (kg/m) - Elements	14.61	17.36	13.34	21.81	26.04	32.18	18.63	30.07	35.36	43.62
Weight (kg/m) - Ends	0.46	0.46	0.56	0.56	0.56	0.56	0.56	0.56	0.56	0.56
Water contents (l/m)	10.59	12.70	12.70	16.94	19.06	23.29	14.82	21.17	25.41	29.64
Wall to tap centre (mm)	54 / 59	54 / 59	73 / 78	73 / 78	73 / 78	73 / 78	91 / 96	91 / 96	91 / 96	91 / 96

55 COLOUR OPTIONS. 14-DAY LEAD TIME.

Stelrad Radiators are available in white (RAL 9016) as standard, however this radiator is **now available in a variety of colours within 14 working days.**

STANDARD COLOUR



RAL 9016
Traffic white

To request up to 5 colour samples, please email sales@stelrad.com or call **0800 876 6813** with your choices and address details.

The colours shown are reproduced as accurately as this printing process will allow.

RAL COLOURS - Satin Finish

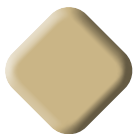

1001
Beige



1013
Oyster white



1015
Light ivory



9001
Cream



9002
Grey white



9003
Signal white



9010
Pure white



9016
Traffic white



9018
Papyrus white

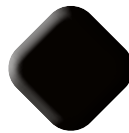

9005
Jet black



9017
Traffic black

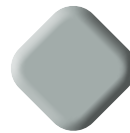

7001
Silver grey

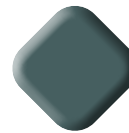

7011
Iron grey

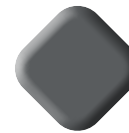

7015
Slate grey

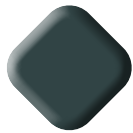

7016
Anthacite grey



7030
Stone grey



7032
Pebble grey



7035
Light grey

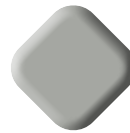

7036
Platinum grey

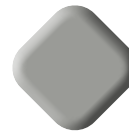

7037
Dusty grey



7038
Agate grey

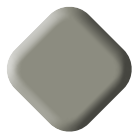

7039
Quartz grey



5002
Ultramarine blue

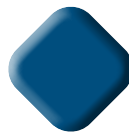

5010
Gentian blue

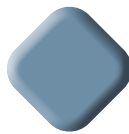

5012
Light blue

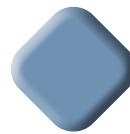

5014
Pigeon blue

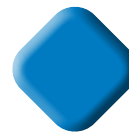

5015
Sky blue

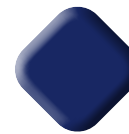

5022
Night blue

Please note: When a coloured radiator or radiators have been ordered they cannot be cancelled or returned.

For further information on RAL colours please visit www.ralcolorchart.com



RAL COLOURS (continued)

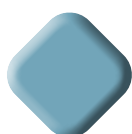

5024
Pastel blue



6005
Light moss green



6018
Yellow green

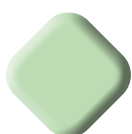

6019
Pastel green

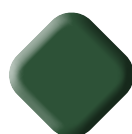

6020
Chrome green



6027
Light green

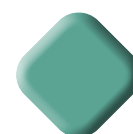

6033
Mint turquoise

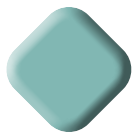

6034
Pastel turquoise



3000
Flame red



3002
Carmine red



3003
Ruby red



3005
Wine red

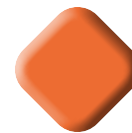

2003
Pastel orange



2008
Bright red orange



1004
Golden yellow



1016
Sulphur yellow



1021
Colza yellow



3015
Light pink

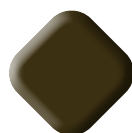

8014
Sepia



8017
Chocolate brown

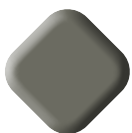

7026
Granite

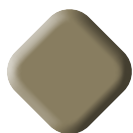

1019
Cappuccino

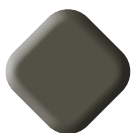

8028
Terra brown

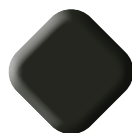

9011
Graphite black

METALLIC

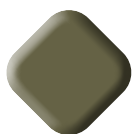

1247M
Bronze metallic



7001M
Silver metallic

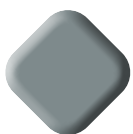

9007M
Grey metallic

Please note: When a coloured radiator or radiators have been ordered they cannot be cancelled or returned.

For further information on RAL colours please visit
www.ralcolorchart.com